

SERVICE AND PARTS MANUAL FOR BLOWER MODEL

SPA DUTY



AMETEK

Technical & Industrial Products

627 Lake Street, Kent, Ohio 44240 U.S.A.

Telephone: 330-673-3451 Fax: 330-677-3306

e-mail: rotronindustrial@ametek.com

internet: www.ametektip.com

Your Choice. Our Commitment.™

WARRANTY, INSTALLATION, MAINTENANCE AND TROUBLESHOOTING INSTRUCTIONS



AMETEK

TECHNICAL AND INDUSTRIAL PRODUCTS

627 Lake Street, Kent, Ohio 44240 USA
Telephone: 330-673-3452 Fax: 330-677-3306

e-mail: rotronindustrial@ametek.com web site: www.ametektip.com

1. AMETEK Rotron DR, EN and HiE regenerative direct drive blowers are guaranteed for one full year from the date of installation (limited to 18 months from the date of shipment) to the original purchaser only. Should the blower fail we will evaluate the failure. If failure is determined to be workmanship or material defect related, we will at our option repair or replace the blower.
2. AMETEK Rotron Minispiral, Revaflow, Multiflow, Nautilair, remote drive blowers, moisture separators, packaged units, CP blowers, Nasty Gas™ models and special built (EO) products are guaranteed for one full year from date of shipment for workmanship and material defect to the original purchaser only. Should the blower fail, If failure is determined to be workmanship or material defect related, we will at our option repair or replace the blower.
3. **Parts Policy** - AMETEK Rotron spare parts and accessories are guaranteed for three months from date of shipment for workmanship and material defect to the original purchaser only. If failure is determined to be workmanship or material defect related we will at our option repair or replace the part.

Corrective Action - A written report will be provided indicating reason(s) for failure, with suggestions for corrective action. Subsequent customer failures due to abuse, misuse, misapplication or repeat offense will not be covered. AMETEK Rotron will then notify you of your options. Any failed unit that is tampered with by attempting repair or diagnosis will void the warranty, unless authorized by the factory.

Terms and Conditions - Our warranty covers repairs or replacement of regenerative blowers only, and will not cover labor for installation, outbound and inbound shipping costs, accessories or other items not considered integral blower parts. Charges may be incurred on products returned for reasons other than failures covered by their appropriate warranty. Out-of-warranty product and in warranty product returned for failures determined to be caused by abuse, misuse, or repeat offense will be subject to an evaluation charge. Maximum liability will in no case exceed the value of the product purchased. Damage resulting from mishandling during shipment is not covered by this warranty. It is the responsibility of the purchaser to file claims with the carrier. Other terms and conditions of sale are stated on the back of the order acknowledgement.

Installation Instructions for SL, DR, EN, CP, and HiE Series Blowers

1. **Bolt It Down** - Any blower must be secured against movement prior to starting or testing to prevent injury or damage. The blower does not vibrate much more than a standard electric motor.
2. **Filtration** - All blowers should be filtered prior to starting. Care must be taken so that no foreign material enters the blower. If foreign material does enter the blower, it could cause internal damage or may exit at extremely high velocity.

Should excessive amounts of material pass through the blower, it is suggested that the cover(s) and impeller(s) be removed periodically and cleaned to avoid impeller imbalance. Impeller

imbalance greatly speeds bearing wear, thus reducing blower life. Disassembling the blower will void warranty, so contact the factory for cleaning authorization.

- Support the Piping** - The blower flanges and nozzles are designed as connection points only and are not designed to be support members.

Caution: Plastic piping should not be used on blowers larger than 1 HP that are operating near their maximum pressure or suction point. Blower housing and nearby piping temperatures can exceed 200°F. Access by personnel to the blower or nearby piping should be limited, guarded, or marked, to prevent danger of burns.

- Wiring** - Blowlers must be wired and protected/fused in accordance with local and national electrical codes. All blowlers must be grounded to prevent electrical shock. Slo-Blo or time delay fuses should be used to bypass the first second of start-up amperage.
- Pressure/Suction Maximums** - The maximum pressure and/or suction listed on the model label should not be exceeded. This can be monitored by means of a pressure or suction gage (available from Rotron), installed in the piping at the blower outlet or inlet. Also, if problems do arise, the Rotron Field representative will need to know the operating pressure/suction to properly diagnose the problem.
- Excess Air** - Bleed excess air off. DO NOT throttle to reduce flow. When bleeding off excess air, the blower draws less power and runs cooler.

Note: Remote Drive (Motorless) Blowlers - Properly designed and installed guards should be used on all belts, pulleys, couplings, etc. Observe maximum remote drive speed allowable. Due to the range of uses, drive guards are the responsibility of the customer or user. Belts should be tensioned using belt gauge.

Maintenance Procedure

When properly piped, filtered, and applied, little or no routine maintenance is required. Keep the filter clean. Also, all standard models in the DR, EN, CP, and HiE series have sealed bearings that require no maintenance. Bearing should be changed after 15,000 to 20,000 hours, on average. Replacement bearing information is specified on the chart below.

Bearing Part Number	Size	Seal Material	Grease	Heat Stabilized
510217 510218 510219	205 206 207	Polyacrylic	Nye Rheotemp 500 30% +/- 5% Fill	Yes - 325 F
510449 516440 516648	203 202 307	Buna N	Exxon Polyrex Grease	NO
516840 516841 516842 516843 516844 516845 516846 516847	206 207 208 210 309 310 311 313	Buna N	Exxon Polyrex Grease	NO

Troubleshooting

		POSSIBLE CAUSE	OUT OF WARRANTY REMEDY ***
IMPELLER DOES NOT TURN	Humming Sound	<ol style="list-style-type: none"> * One phase of power line not connected * One phase of stator winding open Bearings defective Impeller jammed by foreign material Impeller jammed against housing or cover ** Capacitor open 	<ol style="list-style-type: none"> Connect Rewind or buy new motor Change bearings Clean and add filter Adjust Change capacitor
	No Sound	<ol style="list-style-type: none"> * Two phases of power line not connected * Two phases of stator winding open 	<ol style="list-style-type: none"> Connect Rewind or buy new motor
IMPELLER TURNS	Blown Fuse	<ol style="list-style-type: none"> Insufficient fuse capacity Short circuit 	<ol style="list-style-type: none"> Use time delay fuse of proper rating Repair
	Motor Overheated Or Protector Trips	<ol style="list-style-type: none"> High or low voltage * Operating in single phase condition Bearings defective Impeller rubbing against housing or cover Impeller or air passage clogged by foreign material Unit operating beyond performance range Capacitor shorted * One phase of stator winding short circuited 	<ol style="list-style-type: none"> Check input voltage Check connections Check bearings Adjust Clean and add filter Reduce system pressure/vacuum Change capacitor Rewind or buy new motor
	Abnormal Sound	<ol style="list-style-type: none"> Impeller rubbing against housing or cover Impeller or air passages clogged by foreign material Bearings defective 	<ol style="list-style-type: none"> Adjust Clean and add filter Change bearings
	Performance Below Standard	<ol style="list-style-type: none"> Leak in piping Piping and air passages clogged Impeller rotation reversed Leak in blower Low voltage 	<ol style="list-style-type: none"> Tighten Clean Check wiring Tighten cover, flange Check input voltage

* 3 phase units
 ** 1 phase units
 *** Disassembly and repair of new blowers or motors will void the Rotron warranty. Factory should be contacted prior to any attempt to field repair an in-warranty unit.

Blower Disassembly:

WARNING: Attempting to repair or diagnose a blower may void Rotron's warranty. It may also be difficult to successfully disassemble and reassemble the unit.

- 1) Disconnect the power leads. **CAUTION:** Be sure the power is disconnected before doing any work whatsoever on the unit.
- 2) Remove or separate piping and/or mufflers and filters from the unit.
- 3) Remove the cover bolts and then the cover. **NOTE:** Some units are equipped with seals. It is mandatory that these seals be replaced once the unit has been opened.
- 4) Remove the impeller bolt and washers and then remove the impeller. **NOTE:** Never pry on the edges of the impeller. Use a puller as necessary.
- 5) Carefully note the number and location of the shims. Remove and set them aside. **NOTE:** If the disassembly was for inspection and cleaning the unit may now be reassembled by reversing the above steps. If motor servicing or replacement and/or impeller replacement is required the same shims may not be used. It will be necessary to re-shim the impeller according to the procedure explained under assembly.

- 6) Remove the housing bolts and remove the motor assembly (arbor/housing on remote drive models).
- 7) Arbor disassembly (Applicable on remote drive models only):
 - a) Slide the bearing retraining sleeve off the shaft at the blower end.
 - b) Remove the four (4) screws and the bearing retaining plate from the blower end.
 - c) Lift the shaft assembly far enough out of the arbor to allow removal of the blower end snap ring.
 - d) Remove the shaft assembly from the arbor.
 - e) If necessary, remove the shaft dust seal from the pulley end of the arbor.

Muffler Material Replacement:

- 1) Remove the manifold cover bolts and them manifold cover.
- 2) The muffler material can now be removed and replaced if necessary. On blowers with fiberglass acoustical wrap the tubular retaining screens with the fiberglass matting before sliding the muffler pads over the screens.
- 3) Reassemble by reversing the procedure.

NOTE: On DR068 models with tubular mufflers it is necessary to remove the cover and impeller accessing the muffler material from the housing cavity.

Blower Reassembly:

- 1) Place the assembled motor (assembled arbor assembly for remote drive models) against the rear of the housing and fasten with the bolts and washer.
- 2) To ensure the impeller is centered within the housing cavity re-shim the impeller according to the procedure outlined below.
- 3) If blower had a seal replace the seal with a new one.
- 4) Place the impeller onto the shaft making sure the shaft key is in place and fasten with the bolt, washer and spacer as applicable. Torque the impeller bolt per the table below. Once fastened carefully rotate the impeller to be sure it turns freely.
- 5) Replace the cover and fasten with bolts.
- 6) Reconnect the power leads to the motor per the motor nameplate.

Bolt Size	Torque Pound-Force-Foot
1/4-20	6.25 +/- 0.25
5/16-18	11.5 +/- 0.25
3/8-16	20.0 +/- 0.5
1/2-13	49.0 +/- 1
5/8 -11	90.0 +/- 2

Impeller Shimming Procedure:

WARNING: This unit may be difficult to shim. Extreme care may be exercised.

Tools Needed: Machinist's Parallel Bar
Vernier Caliper with depth measuring capability
Feeler gauges or depth gauge

Measure the Following:

- Distance from the flange face to the housing (A)
- Distance from the flange face to the motor shaft shoulder (B)
- Impeller Thickness (C)

Measurements (A) and (B) are made by laying the parallel bar across the housing flange face and measuring to the proper points. Each measurement should be made at three points, and the average of the readings should be used.

$$\text{Shim Thickness} = B - (A+C)/2$$

After the impeller installation (step #4 above) the impeller/cover clearance can be checked with feeler gauges, laying the parallel bar across the housing flange face. This clearance should nominally be $(A-C)/2$.

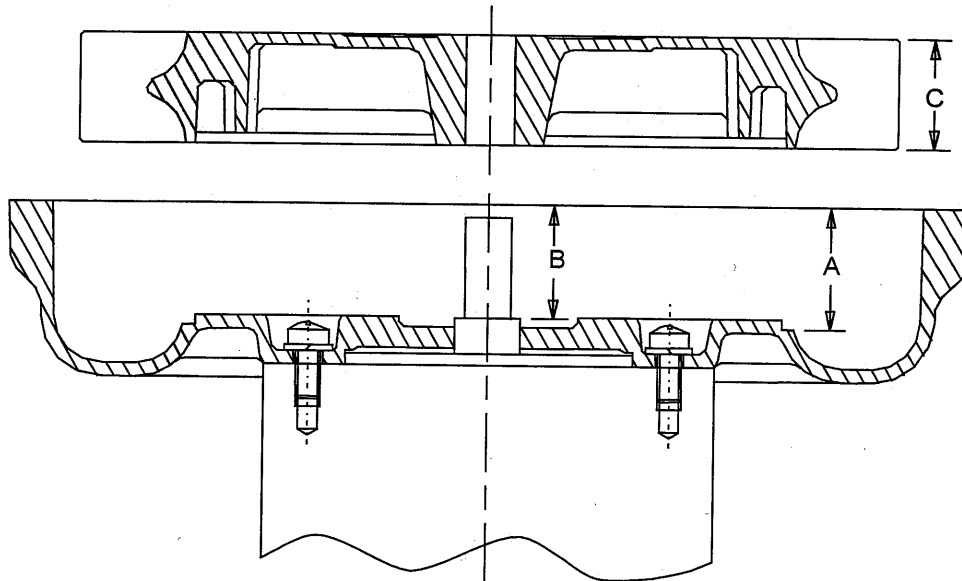

WIRING DIAGRAMS, TEFC and ODP MOTORS

A. 1Ø, 6 WIRE

115 VAC

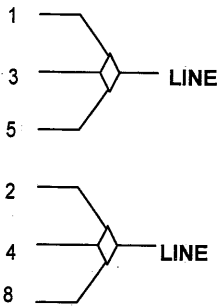

230 VAC

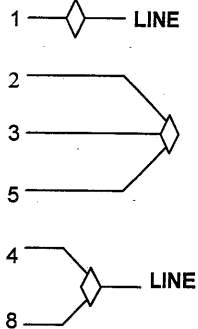

INTERCHANGE LEADWIRES 5 & 8 to REVERSE ROTATION

B. 1Ø, 7 WIRE

115 VAC

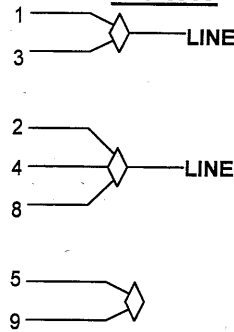

230 VAC

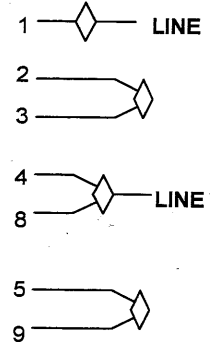

INTERCHANGE LEADWIRES 5 & 8 to REVERSE ROTATION

C. 3Ø, 9 WIRE

230 VAC

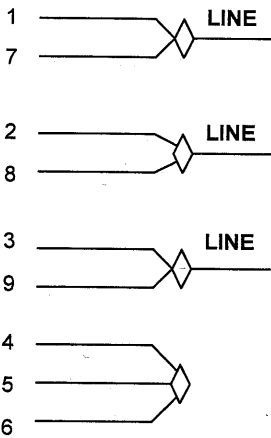

460 VAC

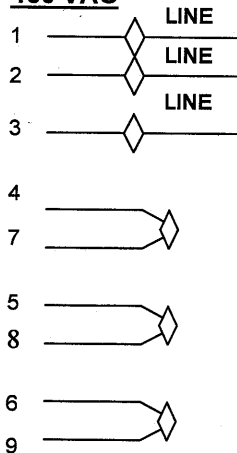

INTERCHANGE ANY TWO LEAD LINES TO REVERSE ROTATION

D. 1Ø, EMERSON 1/8 HP MOTOR

115 VAC

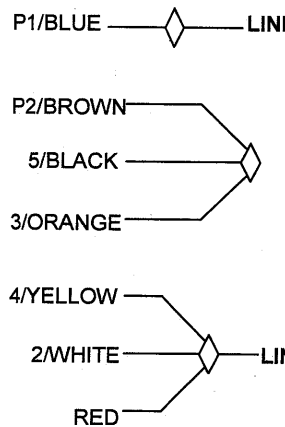

230 VAC

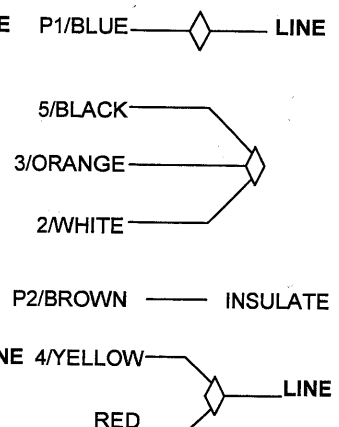

INTERCHANGE RED AND BLACK TO REVERSE ROTATION

E. 1Ø, SPA DUTY WITH TERMINAL STRIPS

LOW 115 VAC

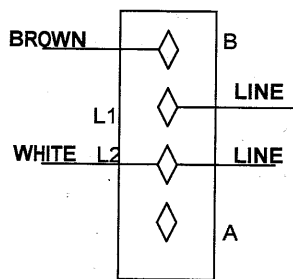

HIGH 230 VAC

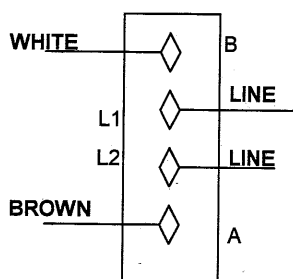

F. 1Ø, 230 VAC

SINGLE VOLTAGE

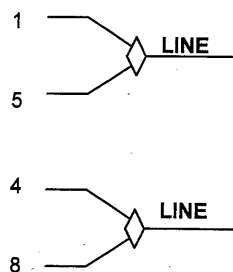

INTERCHANGE LEAD WIRES 5 & 8 TO REVERSE ROTATION

G. 3Ø, 575 VAC

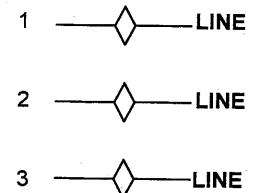

INTERCHANGE ANY TWO LEAD LINES TO REVERSE ROTATION

ASSEMBLY DIAGRAM
DR/EN/CP/HIE X0X

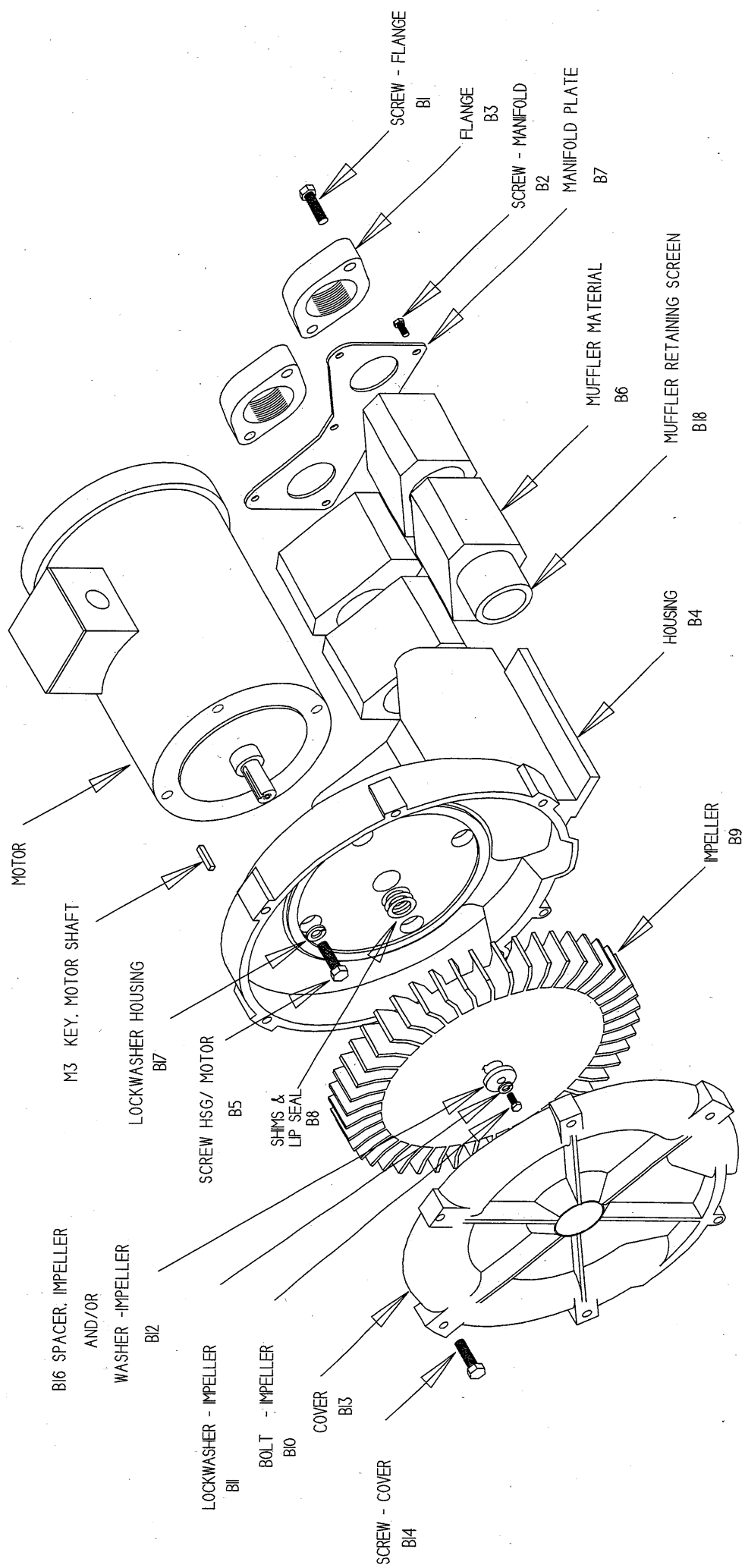

**Spa Blower
Service and Parts Manual**

Parts Breakdown

Model: DR404AQ58M DR454V58 DR505AW58M DR513V58 DR606L5M
 Part No.: 037778 037779 037935 038143 080186
 080485

Item No.	Qty.	Req'd Description							
M3	1	Key Motor Shaft	510629	510629	510629	510629	510629	510629	510629
B1	4	Screw, Flange	120162	120162	120162	120162	120162	120162	120255
B2	6	Screw, Manifold	155130	See Next Page	155130	(10 pcs)	120214	155477	
B3	2	Flange	510962	510354	510354	510354	510354	511480	
B4	1	Housing	517002	See Next Page	517419	516552	529790		
B5	4	Screw, Hsg /Motor	155128	See Next Page	155128	251791	251791		
B6	6	Muffler Material	517015	See Next Page	515743	(4 pcs)	516560	529781	
B7	1	Manifold Plate	517008	515744	517458	529868	511284		
B8	*	Shim .002"	510356	510356	510356	510356	510356	510356	
	*	Shim .005"	510357	510357	510357	510357	510357	510357	
	*	Shim .010"	510358	510358	510358	510358	510358	510358	
	*	Shim .020"	510359	510359	510359	510359	510359	510359	
	*	Shim .030"	Not Used	Not Used	Not Used	Not Used	Not Used	Not Used	
B9	1	Impeller	516987	See Next Page	517433	516557	511272		
B10	1	Bolt, Impeller	120214	120214	120214	120325	120325		
B11	1	Lockwasher, Impeller	120203	120203	120203	120203	120203		
B12		Washer, Impeller	Not Used	Not Used	Not Used	Not Used	Not Used	Not Used	
B13	1	Cover	516990	See Next Page	517431	516559	511274		
B14	6	Screw, Cover	155129	See Next Page	155236	(8 pcs)	120255	(4 pcs)	155236
B16	1	Spacer, Impeller Bolt	510355	510355	510355	510355	510355	510355	
B17	4	Lockwasher, Housing	251787	251787	251787	251787	251787	251787	
B18	1	Screen, Muffler Retaining, Right (**)	517016	See Next Page	517435	511718	529782		
B19	1	Screen, Muffler Retaining, Left (**)	517016	See Next Page	517435	511718	529782		
B20		Bolt, Muffler Hsg/Hsg	Not Used	Not Used	Not Used	Not Used	Not Used	Not Used	
		Muffler Housing	Not Used	Not Used	Not Used	Not Used	Not Used	Not Used	
		Bolt, Motor/Muffler	Not Used	Not Used	Not Used	Not Used	Not Used	Not Used	
		Lockwasher, Motor/Muffler	Not Used	Not Used	Not Used	Not Used	Not Used	Not Used	
		Washer, Motor/Muffler	Not Used	Not Used	Not Used	Not Used	Not Used	Not Used	
		Spacer, Motor/Muffler	Not Used	Not Used	Not Used	Not Used	Not Used	Not Used	

*As needed **Viewed looking at inlet/outlet ports

Model	Part #	Motor	Wiring Diagram	Specific Parts	Bearing, Rear, (M1)	Bearing, Impeller End (M2)
DR404AQ58M	03778	528783	E	B2=155477 B4=515737 B5=251791 B9=515675 B13=551065 B14=155236 B18=510362 B6=(4 pcs) 515743		
DR454V58	03779	551265	E	B2=155130 B4=551001 B5=155128 B9=551067 B13=551065 B14=155129 B18=5151087 B6=(4 pcs) 515743 + (2 pcs) 551006		
DR454V58M	080485	551265	E			
DR505AVV58M	037935	528785	E		Call Factory	Call Factory
DR513V58	038143	551265	E			
DR606L5M	080186	550745	E			
DR656L5M	080605	550745	E		Call Factory	Call Factory

*As needed **Viewed looking at inlet/outlet ports

DR656L5M
080605

510629
120255
155170
511480
550195
251791
(10 pcs) 551585
511284
510356
510357
510358
510359
Not Used
550305
120325
120203
Not Used
550249
(8 pcs) 155236
510355
251787
529782
529782
517436
Not Used
550253
Not Used
Not Used
Not Used

*As needed **Viewed looking at inlet/outlet ports